

### Yard Master 2 Dimensions Table

Unit: mm													
Model Number	Screen Diag. & Aspect Ratio	View Width (A)	Left/Right Border (A1)	Frame Length (A2)	View Height (B)	Frame Height (B1)	Top/Bottom Border (B2)	Bottom of Frame to Ground (B3)	Rope Length (B4)	Carrying Bag Length (A3)	Carrying Bag Height (B5)	Carrying Bag Width (C)	Frame/Tube Width
OMS90H2	90° (16:9)	1992	75	2124	1120	1860	75	590	1917	760	180	240	33
OMS100H2	100° (16:9)	2214	75	2346	1246	1986	75	590	2040	830	180	240	33
OMS110H2	110° (16:9)	2435	75	2567	1368	2108	75	590	2159	910	180	240	33
OMS120H2	120° (16:9)	2657	75	2790	1492	2232	75	590	2280	980	180	240	33
OMS135H2	135° (16:9)	2990	75	3122	1680	2420	75	590	2464	1090	180	240	33
OMS90HR2	90° (16:9)	1992	75	2124	1120	1860	75	590	1917	760	180	240	33
OMS100HR2	100° (16:9)	2214	75	2346	1246	1986	75	590	2040	830	180	240	33
OMS110HR2	110° (16:9)	2435	75	2567	1368	2108	75	590	2159	910	180	240	33
OMS120HR2	120° (16:9)	2657	75	2790	1492	2232	75	590	2280	980	180	240	33
OMS135HR2	135° (16:9)	2990	75	3122	1680	2420	75	590	2464	1090	180	240	33
Unit: Inch													
Model Number	Screen Diag. & Aspect Ratio	View Width (A)	Left/Right Border (A1)	Frame Length (A2)	View Height (B)	Frame Height (B1)	Top/Bottom Border (B2)	Bottom of Frame to Ground (B3)	Rope Length (B4)	Carrying Bag Length (A3)	Carrying Bag Height (B5)	Carrying Bag Width (C)	Frame/Tube Width
OMS90H2	90° (16:9)	78.4	3	83.6	44.1	73.2	3.0	23	75.5	29.9	7.1	9.4	1.3
OMS100H2	100° (16:9)	87.1	3	92.3	49.1	78.2	3.0	23	80.3	32.7	7.1	9.4	1.3
OMS110H2	110° (16:9)	95.9	3	101.1	53.9	83.0	3.0	23	85.0	35.8	7.1	9.4	1.3
OMS120H2	120° (16:9)	104.6	3	109.8	58.7	87.9	3.0	23	89.8	38.6	7.1	9.4	1.3
OMS135H2	135° (16:9)	117.7	3	122.9	66.1	95.3	3.0	23	97.0	42.9	7.1	9.4	1.3
OMS90HR2	90° (16:9)	78.4	3	83.6	44.1	73.2	3.0	23	75.5	29.9	7.1	9.4	1.3
OMS100HR2	100° (16:9)	87.1	3	92.3	49.1	78.2	3.0	23	80.3	32.7	7.1	9.4	1.3
OMS110HR2	110° (16:9)	95.9	3	101.1	53.9	83.0	3.0	23	85.0	35.8	7.1	9.4	1.3
OMS120HR2	120° (16:9)	104.6	3	109.8	58.7	87.9	3.0	23	89.8	38.6	7.1	9.4	1.3
OMS135HR2	135° (16:9)	117.7	3	122.9	66.1	95.3	3.0	23	97.0	42.9	7.1	9.4	1.3

Note : Data Error be ±1"

The listed measurements are for general reference only. Please contact Elite Screens to verify product design and dimensions before attempting to integrate its products with any structural or furniture modification. Although a manufacturer may offer product advice, it may be taken or disregarded at the integrator's discretion. Elite Screens will not be held responsible or be otherwise liable for faulty installations.

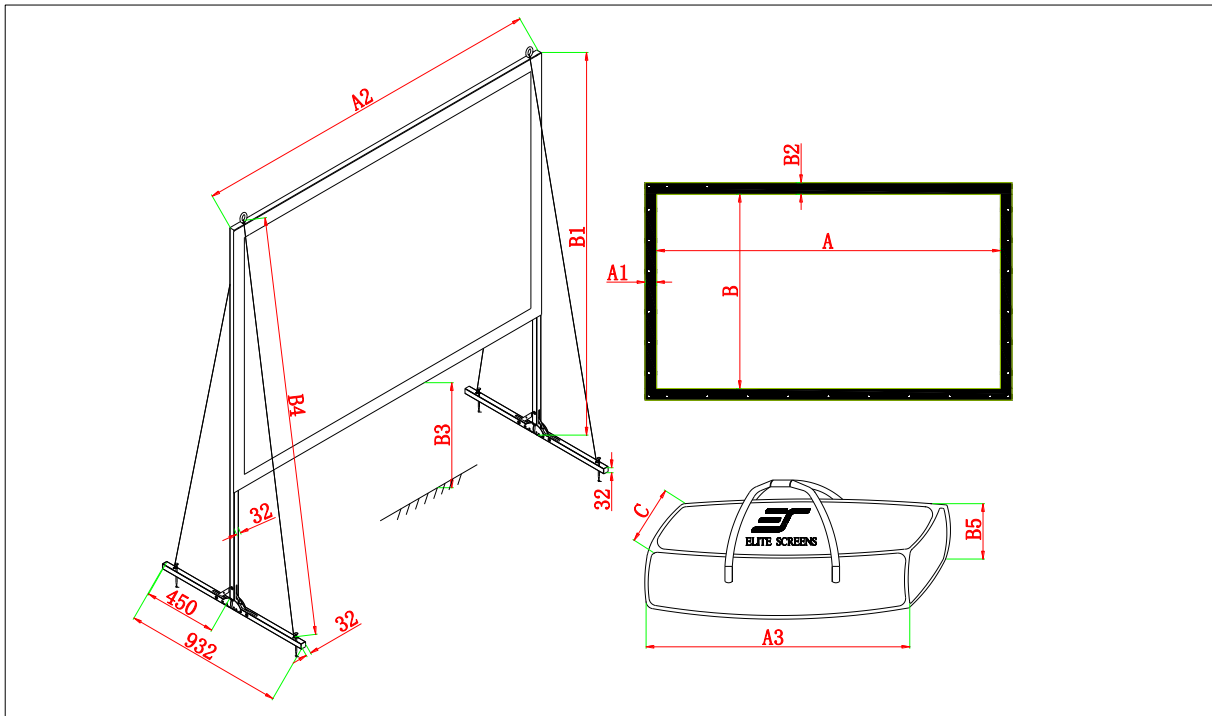



## 2016 Yard Master 2 Series Product Brochure

Yard Master 2 is a folding-frame outdoor projection screen. Its light-weight aluminum frame allows it to be set up in minutes. Simply, unfold the frame; attach the material and legs, then project



# Yard Master 2 Series

Yard Master 2 is a folding-frame outdoor projection screen. Its light-weight aluminum frame allows it to be set up in minutes. Simply, unfold the frame; attach the material and legs, then project

Scan for product



video



## Screen Material:

- CineWhite™-Multi-layer PVC (Polyvinyl chloride) with texture and surface coating, Gain: 1.1
- WraithVeil: Textured PVC with surface coating, Gain 2.2
- View Angle: 180° (90° ±LR).
- Mildew Resistant
- Surface can be cleaned with (water) moist cotton cloth

## Design and Assembly:

- Corner pull-tabs make installation easier
- Single-piece frame system unfolds effortlessly
- Detachable T-legs included
- Assembles in minutes with no tools required

## Portability:

- Light-weight aluminum square tube construction
- Soft-padded carrying bag stores entire product for portability
- Setup and Takedown is simple and quick

## Quality and Reliability:

- Stakes, rope, and support rings included for additional support and stability
- Black masking borders enhance picture contrast
- Standard 2-year parts and labor warranty
- 3-year warranty for ENR-G (Educational, Non-profit, Religious or Government/Military) - US only

## Yard Master 2 Series

Model	Screen Diag. & Aspect Ratio	View Height (in)	View Width (in)	View Height (cm)	View Width (cm)	N.W. (lbs.)	G.W. (lbs.)	Net Wt. (Kgs)	G.W. (Kgs)	Packaging Dimensions (LxHxW)	Gain	Screen Material	Frame Color
OMS90H2	90"(16:9)	44.0	78.0	111.8	198.1	19.0	23.2	8.6	10.5	34.3"x7.7"x11.2"	1.1	CineWhite™	Silver
OMS100H2	100"(16:9)	49.0	87.0	124.5	221.0	20.3	24.7	9.2	11.2	37.8"x7.7"x11.02"	1.1	CineWhite™	Silver
OMS110H2	110"(16:9)	54.0	96.0	137.2	243.8	21.4	26.0	9.7	11.8	40.2"x7.7"x11.2"	1.1	CineWhite™	Silver
OMS120H2	120"(16:9)	59.0	104.7	150.1	265.9	23.0	28.1	10.5	12.8	42.9"x7.7"x11.2"	1.1	CineWhite™	Silver
OMS135H2	135"(16:9)	66.2	117.7	168.1	299.0	29.6	34.6	13.4	15.6	47.2"x7.7"x11.2"	1.1	CineWhite™	Silver
OMS90HR2	90"(16:9)	44.0	78.0	111.8	198.1	19.0	23.2	8.6	10.5	34.3"x7.5"x11.0"	2.2	WraithVeil	Silver
OMS100HR2	100"(16:9)	49.0	87.0	124.5	221.0	20.3	24.7	9.2	11.2	37.8"x7.5"x11.02"	2.2	WraithVeil	Silver
OMS110HR2	110"(16:9)	54.0	96.0	137.2	243.8	21.4	26.0	9.7	11.8	40.2"x7.7"x11.2"	2.2	WraithVeil	Silver
OMS120HR2	120"(16:9)	59.0	104.7	150.1	265.9	23.0	28.1	10.5	12.8	42.9"x7.5"x11.0"	2.2	WraithVeil	Silver
OMS135HR2	135"(16:9)	66.2	117.7	168.1	299.0	29.6	34.6	13.4	15.6	47.2"x7.5"x11.0"	2.2	WraithVeil	Silver
OMS90V2	90"(4:3)	54.0	72.0	137.2	182.9	Information Coming Soon. Refer to Website					1.1	CineWhite™	Silver
OMS100V2	100"(4:3)	60.0	80.0	152.4	203.2	20.7	25.4	9.4	11.5	39.4"x7.7"x11.2"	1.1	CineWhite™	Silver
OMS110V2	110"(4:3)	66.0	88.0	167.6	223.5	Information Coming Soon. Refer to Website					1.1	CineWhite™	Silver
OMS120V2	120"(4:3)	72.0	96.0	182.9	243.8	22.9	29.1	10.4	13.2	45.3"x7.7"x11.2"	1.1	CineWhite™	Silver
OMS135V2	135"(4:3)	81.0	108.0	205.7	274.3	29.8	34.8	13.5	15.8	49.2"x7.7"x11.2"	1.1	CineWhite™	Silver
OMS90VR2	90"(4:3)	54.0	72.0	137.2	182.9	Information Coming Soon. Refer to Website					2.2	WraithVeil	Silver
OMS100VR2	100"(4:3)	60.0	80.0	152.4	203.2	20.7	25.4	9.4	11.5	39.4"x7.7"x11.2"	2.2	WraithVeil	Silver
OMS110VR2	110"(4:3)	66.0	88.0	167.6	223.5	Information Coming Soon. Refer to Website					2.2	WraithVeil	Silver
OMS120VR2	120"(4:3)	72.0	96.0	182.9	243.8	22.9	29.1	10.4	13.2	45.3"x7.7"x11.2"	2.2	WraithVeil	Silver
OMS135VR2	135"(4:3)	81.0	108.0	205.7	274.3	29.8	34.8	13.5	15.8	49.2"x7.7"x11.2"	2.2	WraithVeil	Silver

## Yard Master 2 Dimensions Table

Model	Screen Diag. & Aspect Ratio	View Width (A)	Left/Right Border (A1)	Frame Length (A2)	Carrying Bag Length (A3)	View Height (B)	Frame Height (B1)	Top/Bottom Border (B2)	Bottom of Frame to Ground (B3)	Rope Length (B4)	Carrying Bag Height (B5)	Carrying Bag Width (C)	Frame Width
OMS90H2	90" (16:9)	1992	75	2124	760	1120	1883	75	613	1940	180	250	250
OMS100H2	100" (16:9)	2214	75	2346	830	1245	2008	75	613	2061	180	250	250
OMS110H2	110" (16:9)	2435	75	2567	910	1368	2131	75	613	2181	180	250	250
OMS120H2	120" (16:9)	2657	75	2790	980	1494	2257	75	613	2305	180	250	250
OMS135H2	135" (16:9)	2990	75	3122	1090	1680	2443	75	613	2487	180	250	250
OMS90HR2	90" (16:9)	1992	75	2124	760	1120	1883	75	613	1940	180	250	250
OMS100HR2	100" (16:9)	2214	75	2346	830	1245	2008	75	613	2061	180	250	250
OMS110HR2	110" (16:9)	2435	75	2567	910	1368	2131	75	613	2181	180	250	250
OMS120HR2	120" (16:9)	2657	75	2790	980	1494	2257	75	613	2305	180	250	250
OMS135HR2	135" (16:9)	2990	75	3122	1090	1680	2443	75	613	2487	180	250	250
OMS90V2	90" (4:3)	1829	76	1961	810	1372	2136	76	613	2184	180	250	250
OMS100V2	100" (4:3)	2032	76	2164	889	1524	2286	76	613	2334	180	250	250
OMS110V2	110" (4:3)	2235	76	2367	960	1676	2438	76	613	2484	180	250	250
OMS120V2	120" (4:3)	2438	76	2571	1034	1829	2591	76	613	2634	180	250	250
OMS135V2	135" (4:3)	2743	76	2875	1141	2057	2819	76	613	2858	180	250	250
OMS90VR2	90" (4:3)	1829	76	1961	810	1372	2136	76	613	2184	180	250	250
OMS100VR2	100" (4:3)	2032	76	2164	889	1524	2286	76	613	2334	180	250	250
OMS110VR2	110" (4:3)	2235	76	2367	960	1676	2438	76	613	2484	180	250	250
OMS120VR2	120" (4:3)	2438	76	2571	1034	1829	2591	76	613	2634	180	250	250
OMS135VR2	135" (4:3)	2743	76	2875	1141	2057	2819	76	613	2858	180	250	250

Unit: mm

## Yard Master 2 Dimensions Table

Model	Screen Diag. & Aspect Ratio	View Width (A)	Left/Right Border (A1)	Frame Length (A2)	Carrying Bag Length (A3)	View Height (B)	Frame Height (B1)	Top/Bottom Border (B2)	Bottom of Frame to Ground (B3)	Rope Length (B4)	Bag Height (B5)	Bag Width (C)	Frame Width
OMS90H2	90" (16:9)	78.4	3.0	83.6	29.9	44.1	74.1	3.0	24.1	76.4	7.1	9.8	1.3
OMS100H2	100" (16:9)	87.1	3.0	92.3	32.7	49.0	79.1	3.0	24.1	81.2	7.1	9.8	1.3
OMS110H2	110" (16:9)	95.9	3.0	101.1	35.8	53.9	83.9	3.0	24.1	85.9	7.1	9.8	1.3
OMS120H2	120" (16:9)	104.6	3.0	109.8	38.6	58.8	88.9	3.0	24.1	90.7	7.1	9.8	1.3
OMS135H2	135" (16:9)	117.7	3.0	122.9	42.9	66.1	96.2	3.0	24.1	97.9	7.1	9.8	1.3
OMS90HR2	90" (16:9)	78.4	3.0	83.6	29.9	44.1	74.1	3.0	24.1	76.4	7.1	9.8	1.3
OMS100HR2	100" (16:9)	87.1	3.0	92.3	32.7	49.0	79.1	3.0	24.1	81.2	7.1	9.8	1.3
OMS110HR2	110" (16:9)	95.9	3.0	101.1	35.8	53.9	83.9	3.0	24.1	85.9	7.1	9.8	1.3
OMS120HR2	120" (16:9)	104.6	3.0	109.8	38.6	58.8	88.9	3.0	24.1	90.7	7.1	9.8	1.3
OMS135HR2	135" (16:9)	117.7	3.0	122.9	42.9	66.1	96.2	3.0	24.1	97.9	7.1	9.8	1.3
OMS90V2	90" (4:3)	72.0	3.0	77.2	31.9	54.0	84.1	3.0	24.1	86.0	7.1	9.8	1.3
OMS100V2	100" (4:3)	80.0	3.0	85.2	35.0	60.0	90.0	3.0	24.1	91.9	7.1	9.8	1.3
OMS110V2	110" (4:3)	88.0	3.0	93.2	37.8	66.0	96.0	3.0	24.1	97.8	7.1	9.8	1.3
OMS120V2	120" (4:3)	96.0	3.0	101.2	40.7	72.0	102.0	3.0	24.1	103.7	7.1	9.8	1.3
OMS135V2	135" (4:3)	108.0	3.0	113.2	44.9	81.0	111.0	3.0	24.1	112.5	7.1	9.8	1.3
OMS90VR2	90" (4:3)	72.0	3.0	77.2	31.9	54.0	84.1	3.0	24.1	86.0	7.1	9.8	1.3
OMS100VR2	100" (4:3)	80.0	3.0	85.2	35.0	60.0	90.0	3.0	24.1	91.9	7.1	9.8	1.3
OMS110VR2	110" (4:3)	88.0	3.0	93.2	37.8	66.0	96.0	3.0	24.1	97.8	7.1	9.8	1.3
OMS120VR2	120" (4:3)	96.0	3.0	101.2	40.7	72.0	102.0	3.0	24.1	103.7	7.1	9.8	1.3
OMS135VR2	135" (4:3)	108.0	3.0	113.2	44.9	81.0	111.0	3.0	24.1	112.5	7.1	9.8	1.3

Unit: inch

**Note: Data Error ±1".** The listed measurements are for general reference only. Please contact Elite Screens to verify product design and dimensions before attempting to integrate its products with any structural or furniture modification. Although a manufacturer may offer product advice, it may be taken or disregarded at the integrator's discretion. Elite Screens will not be held responsible or be otherwise liable for faulty installations.

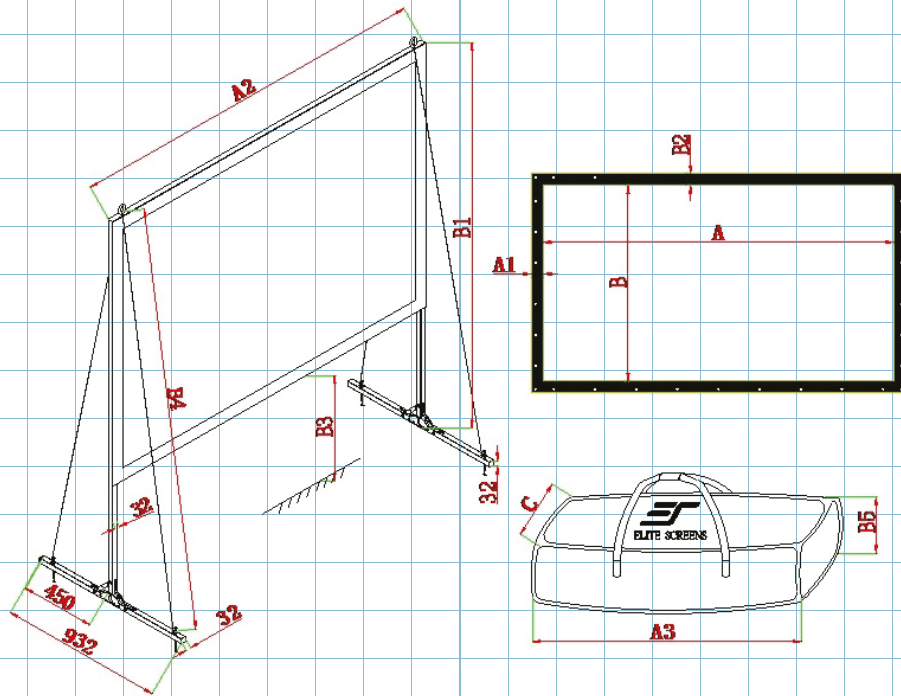



# **Yard Master 2 Series**

## Indoor/Outdoor Portable Projection Screen

### **User's Guide**

Thank you for choosing the *Yard Master 2* portable projection screen! Please read through this user guide before utilizing the screen. Correct usage and maintenance will ensure a long product life

#### **Care & Use Instructions**









- ◆ Please be sure to distinguish between the front and back of the screen fabric when setting up the projection screen. CineWhite (front projection) has a black backing and WraithVeil (rear projection) is labeled front, back.
- ◆ Dust, dirt and scratches on the projection surface will affect the picture quality, please take note of the points below to prevent that from occurring:
  1. Do not touch the projection surface with your hands
  2. Do not write or draw on the projection surface
  3. Do not use fingers or sharp objects to point on the projection surface; this will damage the screen material.
  4. Use a soft-damp cloth to clean the projection surface; do not use chemical cleaning agents or alcohol.
  5. Use clean water when dampening the cleaning cloth and do not rub against the material to clean it.
- ◆ After using the screen, disassemble it and store it in the carrying bag provided.
- ◆ To avoid damage and injury, the screen should only be operated by adults.

#### **Product Description**

**Design:** The aluminum frame is designed to be light weight and easily operated making it easy to carry, assemble and disassemble.

**Screen Fabric:** The screen fabric is attached to the rectangular frame and held in place by several press studs, which ensure an evenly stretched and flat surface. The CineWhite (front projection) and WraithVeil (rear projection) screen materials are durable and can be folded many times without causing damage or distortion to the surface.

## Parts Diagram

<p>A. Folding frame x1</p> 	<p>B. Left and right folding legs x2</p> 	<p>C. Screen material bag x1</p> 
<p>D. Projection screen material x1</p> 	<p>E. Knob screw x2</p> 	<p>F. Eyebolt x2</p> 
<p>G. Rope x2</p> 	<p>H. Carrying Bag x1</p> 	<p>I. Stake x4</p> 

Note: The parts list above is subject to change without notice.

### Correct usage of the projection screen will ensure better viewing results.

For front projection, assemble and view the screen as indicated in Fig.1.

For rear projection, assemble and view the screen as indicated in Fig.2.

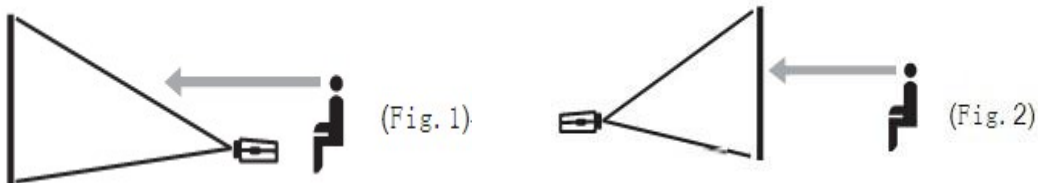

### Frame Assembly and Screen Material Attachment

1. Take the *folding frame (A)* out of the *carrying bag (H)* and place it on a flat surface. Unfold the longer sections first as shown in Fig.3-4.

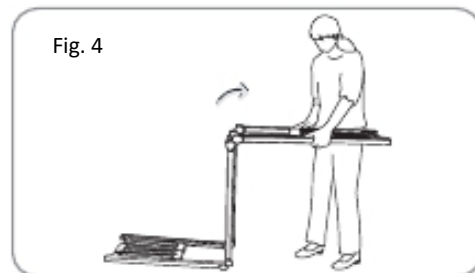
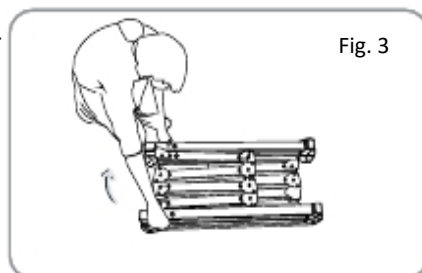

2. Unfold the frame until the latch on the hinge "clicks" into place. Repeat the procedure for the shorter sections.

(Fig. 5-6)

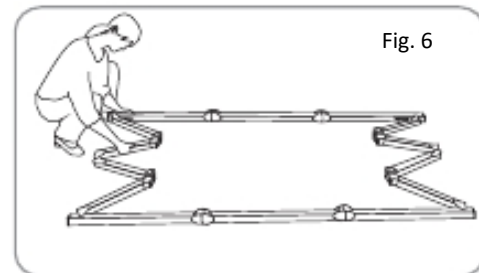
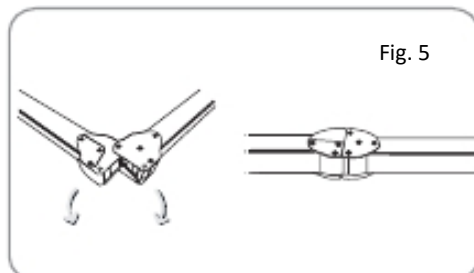

3. Make sure all 4 corners of the frame are at a 90° angle and the hinged support bar is straight and not bending. (Fig. 7-9)

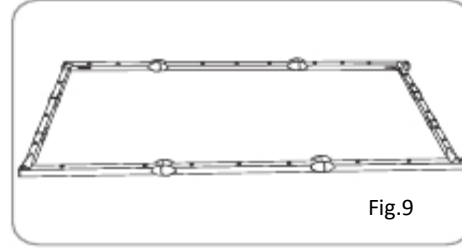
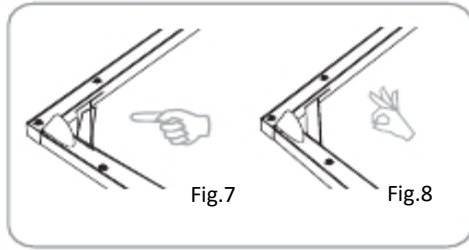

4. Insert the frame **legs (B)** into the openings located at the left and right bottom sides of the **folding frame (A)**. Secure them by fastening the **knob screw (E)** into the adjacent hole. Next, screw the **eyebolts (F)** into the openings located at the top of the frame (Fig.10).

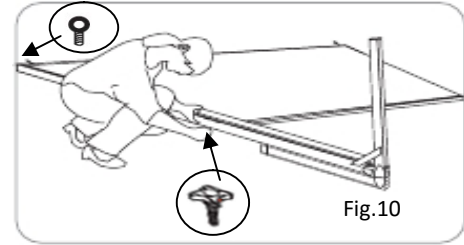

5. Take the **screen material (D)** out of the **screen material bag (C)** and align the corners of the screen material with the inside corners of the frame. Unfold as shown in the diagram (Fig.11-12).

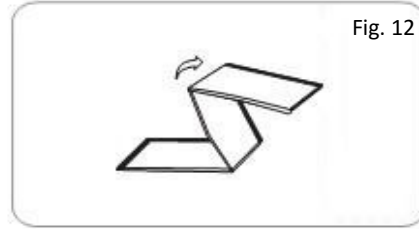

6. Once the **screen material (D)** is fully extended, secure the material by snapping the buttons onto the frame studs as shown in Fig. 13-15. Fasten the buttons in the following order AB→CD→EF→GH.

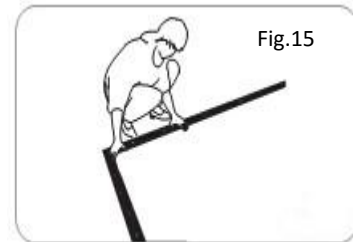
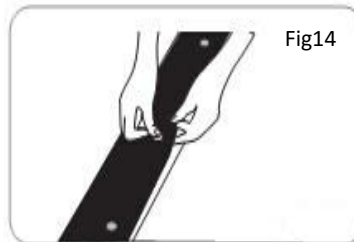
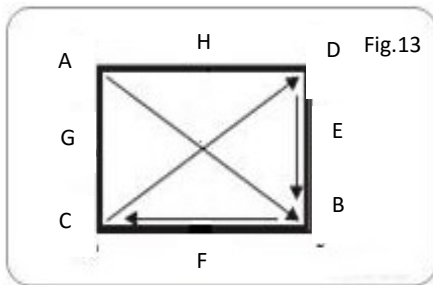

7. Tie 4 pieces of **rope (2 on the left and 2 on the right)** to the **eyebolts (F)** that are located at the top of the frame. Next, lift the screen up while simultaneously opening the frame legs. Two people are needed for this step. Fig.16-17

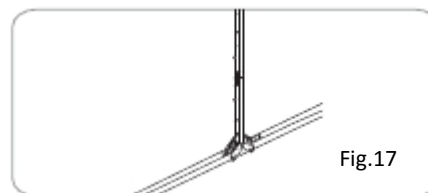



8. To secure the frame, place a **stake (I)** into each hole located on the frame footing, and hammer it into the ground. Finally, tie the 4 **ropes (G)** to the stakes to prevent the screen from tilting or falling over. As shown in fig.18.



Fig.18

## Screen Disassembly

1. Remove **ropes (G) and stakes (I)** from the ground.
2. Unlatch the hinged support bars on front side of each leg so that it is bent and fold that half of the legs up for the next step.
3. Slowly lower the screen to the ground (towards the closed legs). Two people are needed for this step.

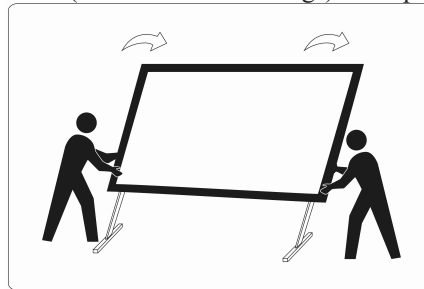

4. Unlatch the hinged support bars and fold down other half of legs.
5. Loosen and remove the ropes, **knob screws (E)** and **eyebolts (F)** from each leg.

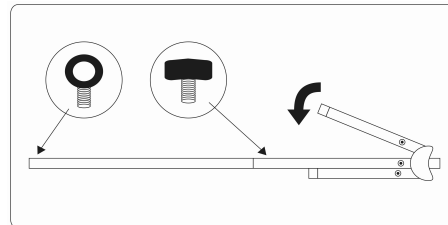

6. Remove the frame **legs (B)** from the **folding frame (A)**.
7. Detach the **screen material (D)** from the **folding frame (A)** by carefully unsnapping each button as shown.



8. Fold **screen material (D)** in half, folding the bottom of the screen towards the top. Then, fold in half again in the same way. Lastly, fold the material into thirds to condense the length, see Fig. 19 – 21.

\*If you prefer to roll the material, instead of folding into thirds, roll from one end to the other after folding in half twice.

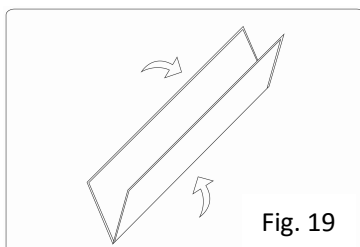

Fig. 19

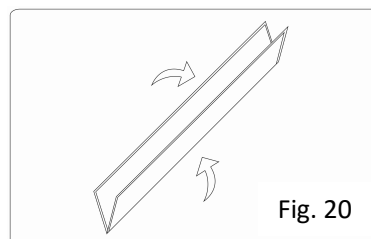

Fig. 20

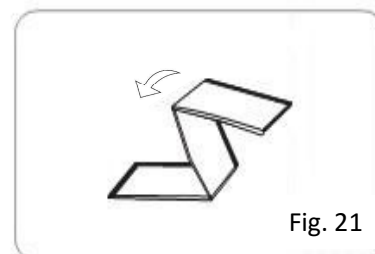
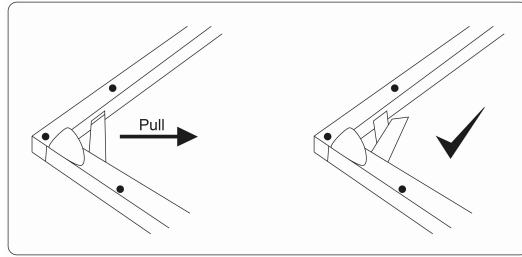
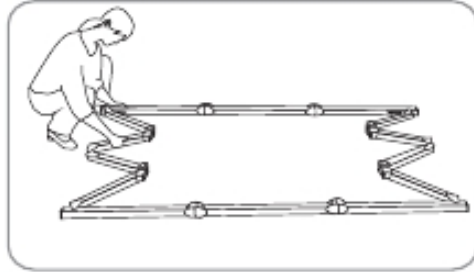

Fig. 21

9. Unlatch the hinged support bars in each corner of the *folding frame (A)*.



10. Press in the silver locking buttons, near the folding joints, and slowly gather the sides of the folding frame



11. Again, press in the silver locking buttons. Then, pick up one end of the folding frame, and walk it to the other end, folding the longer sections into thirds.

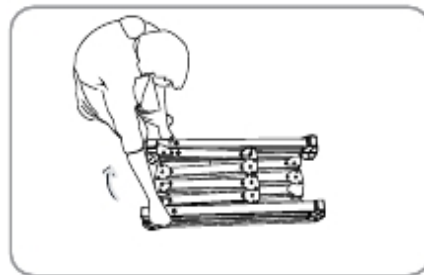
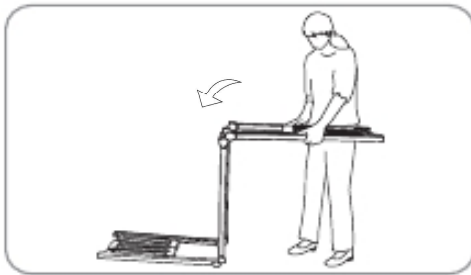

12. Store the screen in the provided *carrying bag (h)*. Be sure to place folding frame, legs, and smaller parts into the carrying bag first and place the material on top to keep material from creasing or tearing.



For a local Elite Screens contact or Technical Support, please visit  
[www.elitescreens.com](http://www.elitescreens.com)



The *WraithVeil Dual* is a 2-directional flexible vinyl projection screen material. It is designed to accommodate either front or rear projection. This versatile material eliminates the need to swap out the projection material to accommodate a front or rear projector array. It offers a 150° wide viewing angle and color balance for a variety of presentations.

The *WraithVeil Dual* performs best under controlled room lighting, but is capable of providing excellent performance with mild levels of ambient light when using a high lumens standard or ultra/short-throw projector.

**Screen Material**

- Gain: 0.8; Viewing Angle: 150° (75°LR)
- 2-Directional Front/Rear Projection
- Provides exceptional color balance and high resolution
- Broad viewing cone for edge blending applications
- Compatible with ultra, short and standard throw projectors
- 4K Ultra HD, HDR, and Active 3D Ready
- Surface cleaned with mild soap, water and a soft cloth
- Flexible PVC allows proper tension for uniform flatness
- Mildew Resistant

Elite Screen series:  
Yard Master 2 Dual



On-axis 0° Gain: 0.8  
Viewing Cone: 150°

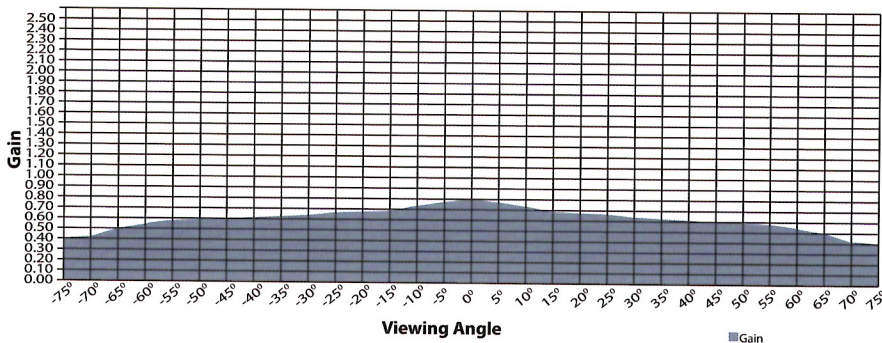



## Elite Screens Europe Projection Screen Materials Chart

Screen Material Name	MaxWhite®	MaxWhite® Fiberglass	CineWhite®	WraithVeil®	WraithVeil® Dual	CLR®
Picture						
Description	MaxWhite® is the most versatile screen surface for front projection presentations. This material provides a wide viewing angle with perfect diffusion uniformity while delivering radiant images and color reproduction	MaxWhite® FG is fiberglass backed for added stiffness which provides the strong durability and is tearproof. This material has uniform diffusion, excellent color reproduction and black & white contrast.	CineWhite® has a broad light dispersion through diffusion uniformity. It enhances black & white levels while colors remain neutral. Perfectly flat projection material for the most demanding applications.	WraithVeil® is our rear projection screen material. It has a high gain performance for applications with high levels of ambient light. Its special surface coating enhances color reproduction.	The WraithVeil® Dual is a front/rear projection material designed to accommodate both projection methods. This 2-in-1 material eliminates the need to swap out the viewing surface which makes this a very versatile product.	CLR® is a ceiling light-rejecting front projection material designed specifically for tabletop-mounted ultra-short-throw projectors. The CLR® features a multilayer optical lens structure that absorbs light from above while providing a clear image. This allows the picture to be free from washing out the projected image.
Available in Screen Series	Manual, Manual SRM, Tripod, ezCinema, Spectrum, VMAX	Manual HT, Saker, Saker Tab-Tension, Evanesce B	Aeon Edge free, Sable Frame/B 2, ezFrame, Lunette, Evanesce Tab-Tension, Evanesce Tab-Tension B, Yard Master 2	Yard Master 2, Quick Stand	Yard Master 2	Aeon® CLR, Saker Tab-Tension CLR, Kestrel CLR
Type of material	Matte White (multi-layer weave)	Matte White (multi-layer weave with fiberglass reinforcement)	Tensioned Matte White (PVC Flexible)	Dark Grey (PVC Flexible)	Light Grey (PVC Flexible)	Dark Gray (TPU)
Projection Type	Front	Front	Front	Rear	Rear/Front	Front
Ambient Light Rejecting	No	No	No	No	No	Yes (up to 95%)
Gain	1.1	1.1	1.1	2.2	0.8	0.6
Viewing Angle	180°	180°	180°	120°	150°	180°
Black backing	Yes	Yes	Yes	N/A	N/A	Yes
3D Ready	Active 3D	Active 3D	Active 3D	Active 3D	Active 3D	Active
4K/8K Ultra HD Ready	Yes	Yes	Yes	Yes	Yes	Yes
Projector Type Compatible	regular projector	regular projector	electric screens = just regular projectors; fixed frame screens= regular, short and UST projector	regular, short throw and UST projector	regular, short throw and UST projector	Ultra-Short Throw (UST) projector (tabletop only)
Minimum Throw Ratio	0.2 x image width	0.2 x image width	0.2 x image width	0.8 x image width	0.2 x image width	0.1 - 0.4
Best for Environments	Versatile for multiple applications in a light controlled room	Versatile for multiple applications in a light controlled room	Versatile for multiple applications in a light controlled room	DJ events, Rental & Staging, ProAV, any applications requiring a rear projection system.	Rear or Front applications for Rental & Staging, ProAV, DJ events in a light controlled environment.	High ambient light control rooms and dark rooms
GREENGUARD Certified	Yes	Yes	No	No	No	No
Flame Retardant	No	Yes, complies with NFPA 701	No	No	No	No
Reflective technology type	-	-	-	-	-	Retro-Reflective
Scotch-resistant	-	-	-	-	-	No
ISF Certified	No	No	No	No	No	No



Screen Material Name	CineGrey 3D®	CineGrey 5D®	DayWalker DW3	AcousticPro 1080P3	AcousticPro UHD
Picture					
Description	The CineGrey 3D® is a reference quality front projection screen material formulated for environments with minimal control over lighting. It was designed to enhance picture brightness, produce accurate color fidelity, and improve contrast levels.	The CineGrey 5D® is a front projection material designed to reject ambient light while maintaining superb picture quality. It's an ideal fit for rooms that have little or no control over incidental light and allows projector to reflect more light towards the viewer.	The DayWalker DW3 is a reference quality front projection screen material formulated for environments with minimal control over lighting. It was designed to enhance picture brightness, produce accurate color fidelity, and improve contrast levels.	The AcousticPro 1080P3 is the ultimate acoustically sound transparent front projection material. The tight angular weave eliminates the moire effect while presenting warm neutral colors. The AcousticPro 1080P3 allows speaker placement behind while allowing an exceptional acoustically transparent performance.	The AcousticPro UHD is a moiré-free acoustically transparent front projection screen material. The dense synthetic weave is compatible with Ultra-High Definition/4K resolutions. The AcousticPro UHD design maximizes sound penetration with minimal attenuation without compromising picture quality.
Available in Screen Series	Sable Frame, Aeon EDGE FREE®	ezFrame, Aeon Edge free, Saker Tab-Tension	DayWalker fixed frame, DayWalker electric	Sable Frame, ezFrame, Lunette	Aeon Edge free, Saker Tab-Tension
Type of material	Silver/Gray (PVC Flexible)	Silver/Gray (PVC Flexible)	Silver/Gray (PVC Flexible)	White - Acoustically Transparent	White - Acoustically Transparent
Projection Type	Front	Front	Front	Front	Front
Ambient Light Rejecting	Yes (up to 65%)	Yes (up to 75%)	Yes (up to 65%)	No	No
Gain	1.2	1.5	1.3	1.1	1.0
Viewing Angle	90°	80°	90°	180°	180°
Black backing	no	no	no	Black scrim included	Black scrim included on Aeon only
3D Ready	Active/Passive	Active/Passive	Active/Passive	Active 3D	Active 3D
4K/8K Ultra HD Ready	Yes	Yes	Yes	Yes	Yes
Ultra/Short-Throw projector compatible	No	No	No	Yes	Aeon AUHD only
Minimum Throw Ratio	1.5 x Image Width	1.5 x Image Width	1.5 x Image Width	0.3 x image width	0.3 x image width
Best for Environments	Moderate ambient light control rooms and dark rooms	High ambient light control rooms and dark rooms	Moderate ambient light control rooms and dark rooms	In-wall speaker or behind speaker placement for 1080P and 4K projectors in a controlled room environment.	In-wall speaker or behind speaker placement for 1080P and 4K projectors in a controlled room environment.
GREENGUARD Certified	Yes	Yes	No	No	No
Flame Retardant	Yes, Complies with NFPA 701	Yes, complies with NFPA 701	No	Yes, Complies with NFPA 701	Yes, Complies with NFPA 701
reflective technology type	Angular-Reflective	Angular-Reflective	Angular-Reflective	N/A	N/A
Polarized for Passive 3D	yes	yes	yes	No	No
ISF Certified	yes	yes	no	No	No
Hole Size	-	-	-	0.178 mm	0.32 mm (avg)
Composition	-	-	-	Polyester Fabric	Polyester/PVC (off-white) - sheer weave
Acoustic Transparency (Mean attenuation)	-	-	-	- 3.09 dB	- 2.36 dB